

ITEM NO.	PART NUMBER	DESCRIPTION	QTY.	COMPONENT NOTES
1	TLY-1P	NEMA 1-15P, polarized	1	black overmold
2	TLY-22S	C7	1	black overmold
3	30-00246	Wire, 2C, 18 AWG, UL SPT-2, 300V, 105C, 7.05 mm, VW-1, PVC	1	
4	Label	Adhesive flag, 15x100mm	1	white with black font

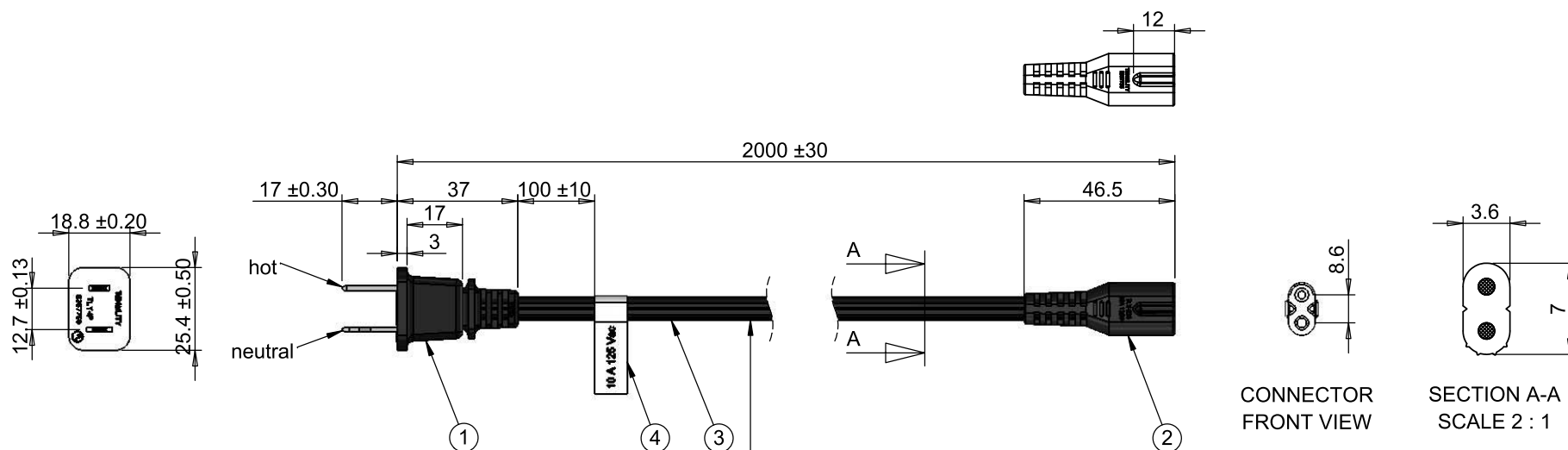

Wire marking: (UL) E339575 SPT-2 2X0.824mm2
 (18AWG) 105C 300V VW-1 C(UL) SPT-2 2X0.824mm2
 (18AWG) 105C 300V VW-1 TENSILITY HLE

CONNECTOR
FRONT VIEW

SECTION A-A
SCALE 2 : 1

Wiring Diagram	
TLY-1P	wire
hot	round
neutral	grooved

Notes:
Electrical requirements: 10 A at 125 Vac

Revision:	Date:	Description:	Prepared:	Notes:	<h1>TENSILITY</h1> <p>tel 1.541.323.3228 800 877.670.7118 fax 1.541.323.4202 web tensility.com</p>
A	12/20/2016	Initial release	DN <small>Digitally signed by DN Date: 2017.01.26 11:43:15 -08'00'</small>	RoHS compliant	
			Verified: PS <small>Digitally signed by PS Date: 2017.01.26 16:03:48 -08'00'</small>	Function test: no open, no short circuit, no intermittent	
			Dimensions are in millimeters. Tolerances: X: ± 0.5 mm X.X: ± 0.3 mm X.XX: ± 0.05 mm	Description: Ac cord, 2000 mm, U.S, NEMA 1-15P plug, TLY-1P to C7, TLY-22S, 18 AWG, SPT-2 wire, 30-00246	
				Size: A Part number: 11-00027	

Scale: 1:2



Sheet 1 of 1